

General Description

The Kimdu Technologies' Avionics Serial Interface Unit (ASIU) is a flight-qualified, COTS piece of equipment that can be ordered with eight ARINC-429/575 channels (4 transmitters and 4 receivers), up to two ARINC-561 channels (2 transmitters and 2 receivers), four RS-232/422 channels, a Dual-Redundant Mil-Std-1553, 10/100 Ethernet, and a CAN2.0 or AeroCAN interface. It can translate between the different protocols using the Kimdu Technologies default protocol or by a customer-supplied definition. The protocol conversions are performed by the embedded CPU. The ARINC-429 interface includes a number of options including: Data Rate (12.5Kbps/100Kbps) and Parity (Normal/Disabled). There are up to four serial ports which can operate a various baud rates. The Mil-Std-1553 interface can operate as either a Bus Controller, Remote Terminal or Bus Monitor. An internal mezzanine [Adapter] Board socket allows for custom interfaces to be easily added.

Firmware Uploading Operation

The ASIU has a dedicated serial port for firmware uploads. Firmware upload is easily accomplished in the field by using the Kimdu-supplied "Loader" software utility and a PC with a serial port. A serial HEX file can be supplied that can be uploaded to the ASIU at the customer's site.

Discrete I/O

The ASIU contains an optional BIT discrete output which is under software control. The operation of this bit is determined by the customer's requirement. Contact the sales group at Kimdu Technologies for details.

ASIU-E



FEATURES:

- ◆ COTS
- ◆ Protocol Conversion between multiple interfaces
- ◆ Ruggedized, Qualified Unit
- ◆ MIL-C-26482 Connectors (MIL-38999 can be ordered)
- ◆ Mil-Std-704A-F 28vDC Power Supply
- ◆ Optional BIT Discrete Output

Up to 8 ARINC-429 Channels

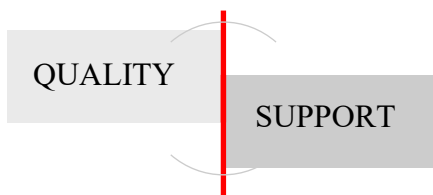

Kimdu Technologies, LLC

1662 Old Country Rd. #9
Plainview, New York 11803

Tel: 1 800 677-6174 Fax: 1 866 447-8644
E-mail: sales@kimducorp.com

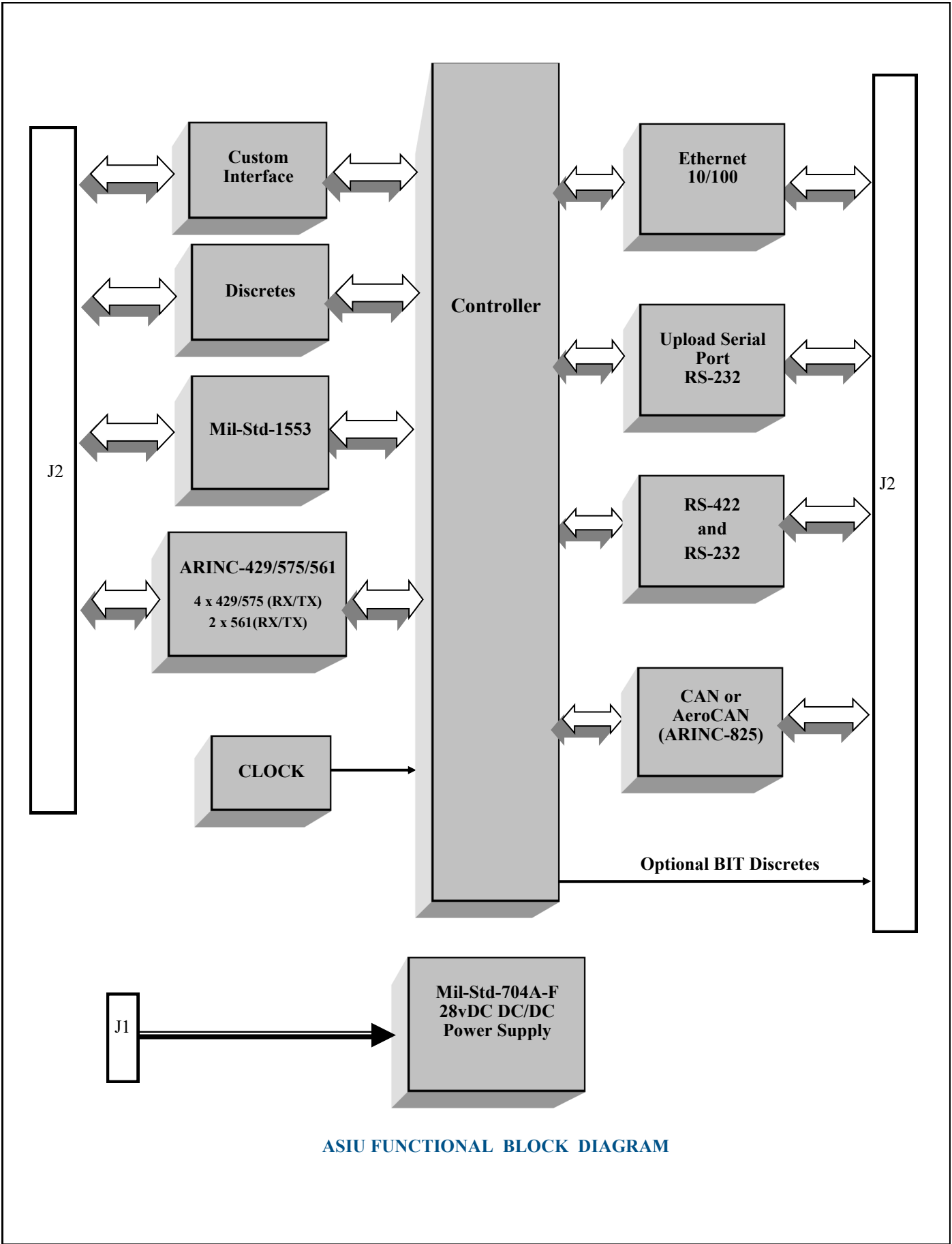

ASIU FUNCTIONAL BLOCK DIAGRAM

System General Definition and Capability

The ASIU converts data between different protocols. Examples include ARINC-429 data to RS-233 or RS-422, RS-422 to 1553. Many variations are possible with the ASIU-E. The protocol conversions are performed and formatted by the embedded CPU according to the customer's requirements or a Kimdu-standard conversion implementation.

This document is not meant to explain the different protocols but some basics are described here. There are no industry-standard conversion algorithms and therefore Kimdu Technologies relies on a definition supplied by the customer or on the Kimdu-defined "Standard Firmware" mode. When using Custom firmware, all elements are programmable; data words, timing, bit manipulation, etc. can be defined by the customer. This allows the ASIU to operate *transparently* between two or more avionics boxes.

The ASIU contains *optional* BIT capabilities in both the hardware and software levels. In addition, a real-time, continuous self-test can be performed which monitors the communications. In the event of a detected failure, the ASIU enables its BIT Failure discrete to signify an ASIU failure condition.

After Power On, the ASIU will detect if it is in the RUN mode or the Firmware Upload Mode - depending upon the state of the UPLOAD EN pin on the I/O connector.

"Standard" ARINC-Serial Firmware Mode

The diagram below illustrates the Standard Firmware structure used for protocol conversion. No software DLL drivers are required to send and receive ARINC data. Serial strings are transferred over the RS-232 or 422 interface. The first byte is the Command byte followed by the data bytes. When sending ARINC data, four bytes are loaded into the ARINC-429 transmitter and sent out. This means that the 4 bytes need to be pre-formatted so that reside in the bit positions that are required/desired for them in the ARINC word. The same is true for the reception of ARINC words. A 32-bit ARINC word is split into 4 bytes [plus the ARINC-429 Channel Indicator] and sent out on the RS-232, 422 or USB interface in the order they were received (Channel Indicator followed by the 8-bit ARINC label, etc.).

SEE ADDENDUM "A" AT THE END OF THIS
DOCUMENT FOR DETAILS

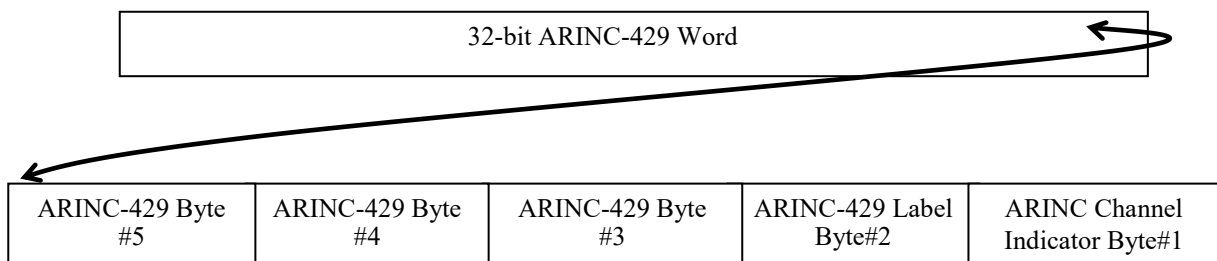

ARINC-429 to RS-422/232 Conversion

Example:

Multi-channel ARINC-429 to Serial operation. When using Standard Firmware, the user can, for example, translate between up to four ARINC channels and one Serial data bus in both directions. Custom firmware allows for using up to four ARINC and four serial data buses concurrently and move the data between channels. These are just examples and given the number of ARINC-429 and RS-232/422 channels, there are many possibilities.

Method of Defining Conversions for Custom Firmware Requirements

We suggest the creation of an ICD which defines the conversion. Which bit goes where, which byte or word to use, the timing between messages or bytes in the case of RS-422/232/485. After Kimdu receives the ICD, it will review it and make any comments and highlight any issues that may require more detail.

Mil-Std-1553 Protocol Conversion

Mil-Std-1553 is based on a message structure using Command words, Data words, and Status words. The words are 16 bits in length and the Mil-Std-1553 specification does not define the contents of the data words - the meaning of the data is defined by the particular program's system specification. There are three types of interfaces ["terminals"] defined by the 1553 standard; the Bus Controller (BC), Remote Terminal (RT), and the Bus Monitor (BM, or MT) - the ASIU can operate as either one. A single [dual-redundant] bus contains a single Bus Controller, up to 32 Remote Terminals (actually 31 if we consider Broadcast messages). In comparison, ARINC-429 uses a single 32-bit word which contains an 8-bit label, SSM bits, parity and data bits while RS-422/232/485 is much less structured than ARINC and defines only the hardware [physical] layer - [8-bit] bytes transmitted and received at a certain baud rate (start/stop bits and parity options are options, as well).

ARINC-429 and MIL-STD-1553

1553 Remote Terminal to/from ARINC-429 - Example and Considerations

1. The Basics

The 1553 RT receives a message with a specific Subaddress and, for example, 3 data words. The system specification defines the meaning of each word and bit. Those three words need to be "realigned" and placed in specific locations within the single [32-bit] ARINC-429 word. The customer must define this conversion.

2a. Data Buffering

Since there is no synchronization between the two interfaces and they both operate at different speeds (1mbps vs. 12.5/100 kbps) there is a good chance that similar data will be received over one interface before it is commanded to be transmitted over the other. In addition, there is a chance that at the time of transmission, the associated data is in the middle of being received creating an "old data/new data" phenomena whereby the received data [buffer] contains old and new data. A very large buffer won't relieve this problem because there will never be such a latency in most systems. We suggest using a double buffer approach for each 1553 message data [block] and each ARINC-429 word. The ASIU will only send data, when commanded, if it is a *complete* word or message. It will then switch to the alternate buffer and begin writing to it, etc.

2b. 1553 “Busy” Option

The Mil-Std-1553 specifications allows for a “busy” option whereby the RT, if requested to transmit, can elect to set the BUSY bit within the 1553 Status word in the event that its data is not “ready”. This function may look attractive to deal with a possible data buffering or “old data, new data” problem. A word of caution; the “BUSY” function is only an *option* and its use, when not defined by the Program’s system specification, will only create 1553 error messages. If the system specification does not define its use, the BC will not be handling it (in its firmware) and therefore will see a 1553 Status word returned without data thus causing an error condition. The bottom line is: don’t use “busy” as a method to deal with data buffering issues unless dictated by the Program’s System specification. This leaves either the double-buffer method or an alternate method defined by the user and implemented by Kimdu Technologies.

Mil-Std-1553 and RS-422/232 Considerations

The same considerations used for ARINC to 1553 need to be taken into account for byte-oriented serial interfaces such as RS-422/232. The difference is the RS-422 has no standard “message” protocol but rather a definition on the byte level; number of bits, baud rate, parity, etc. When translating between the two, again, there are two methods; standard protocol whereby command strings are sent to the ASIU in order to read or write data & status or using a customized protocol conversion whose definition is supplied to Kimdu and implemented in the firmware. Standard command strings can contain functions such as setting 1553 mode, reading or writing 1553 data blocks, etc.

Optional BIT functions

The BIT [Fail] discrete can be activated if one or more of the following failures are detected:

- ♦ Loss of input voltage (28VDC)
- ♦ Loop-Back Test (depending on interface)
- ♦ No communication (within window T_w - defined by the customer)

The following is the Unit’s logic for the BIT/FAIL operation:

- ♦ BIT/FAIL – Unit’s discrete is in the OPEN state.
- ♦ System Operating Properly – Unit’s discrete is in the GND state.

The bit function can be disabled or operate in an alternate mode depending upon the customer requirements.

Notes:

BIT OUTPUT signal is referenced to 28VDC main power and the unit’s Chassis Ground (the chassis ground is connected to the 28V RTN).

Connector Definitions :

Connector Type: MIL-C-26482 Series 2

P1 - POWER

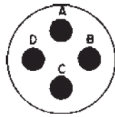

14-4

PIN	FUNCTION
A	+28VDC
B	+28VDC
C	28VDC RTN
D	28VDC RTN

P2 Connector

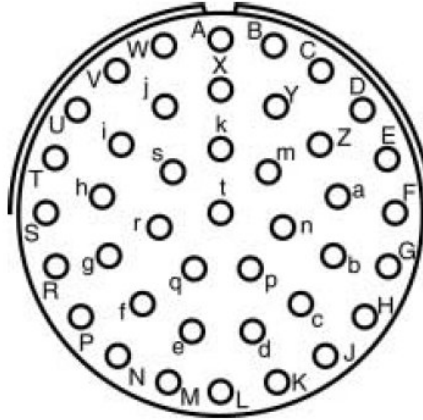

20-41

Mating Connector:
MS3475L14-4S

Mating Connector:
MS3475L20-41P

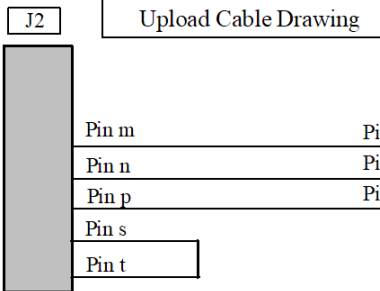

ASIU Side

PC Side



DB-9 Female

Notes:

- (1) Mating connectors are not included. They can be ordered through Kimdu Corp. Contact us for details.
- (2) Pins "s" and "t" must be open on the mating connector for the unit to be in the "operating" mode. For Uploading mode, pins "s" and "t" must be shorted together.

All GND pins on the J2 connector are *sourced* by the ASIU and are at Logic Ground potential. They are meant for external wiring from the J2 connector such as RS-232 GND signal to an external device.

P2 – SIGNAL I/O*

PIN	FUNCTION
A	429RCV+ CH1
B	429RCV- CH1
C	429RCV+ CH2
D	429RCV- CH2
E	429TX+ CH1
F	429TX- CH1
G	429TX+ CH2
H	429TX- CH2
J	429RCV+ CH3
K	429RCV- CH3
L	429RCV+ CH4
M	429RCV- CH4
N	429TX+ CH3
P	429TX- CH3
R	429TX+ CH4
S	429TX- CH4
T	RS-422 TX+ CH1
U	RS-422 TX- CH1
V	RS-422 RX+ CH1
W	RS-422 RX- CH1
X	RS-422 TX+ CH2
Y	RS-422 TX- CH2
Z	RS-422 RX+ CH2
a	RS-422 RX- CH2
b	RS-422 TX+ CH3
c	RS-422 TX- CH3
d	RS-422 RX+ CH3
e	RS-422 RX- CH3
f	RS-422 TX+ CH4
g	RS-422 TX- CH4
h	RS-422 RX+ CH4
i	RS-422 RX- CH4
j	BIT (Discrete Output)
k	GND
m	RS-232 TX UPLOAD
n	RS-232 RX UPLOAD
p	RS-232 GND
q	- unused -
r	GND
s	UPLOAD
t	GND

*ARINC-429 to RS-422 pinout. For other interfaces contact Kimdu Technologies for Pinout.

Connector Definitions :

Connector Type: MIL-C-26482 Series 2

P1 - POWER

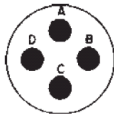

14-4

PIN	FUNCTION
A	+28VDC
B	+28VDC
C	28VDC RTN
D	28VDC RTN

Mating Connector:
MS3475L14-4S

P2 Connector

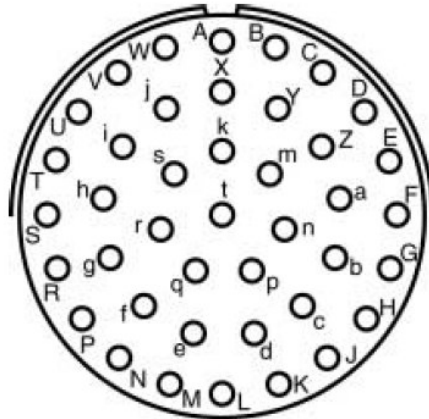

20-41

Mating Connector:
MS3475L20-41P

J2

Upload Cable Drawing



Pin m	Pin 2
Pin n	Pin 3
Pin p	Pin 5
Pin s	
Pin t	

ASIU
Side



PC
Side



DB-9 Female

Notes:

- (1) Mating connectors are not included. They can be ordered through Kimdu Corp. Contact us for details.
- (2) Pins "s" and "t" must be open on the mating connector for the unit to be in the "operating" mode. For Uploading mode, pins "s" and "t" must be shorted together.

All GND pins on the J2 connector are *sourced* by the ASIU and are at Logic Ground potential. They are meant for external wiring from the J2 connector such as RS-232 GND signal to an external device.

P2 – SIGNAL I/O*

PIN	FUNCTION
A	429RCV+ CH1
B	429RCV- CH1
C	429RCV+ CH2
D	429RCV- CH2
E	429TX+ CH1
F	429TX- CH1
G	429TX+ CH2
H	429TX- CH2
J	429RCV+ CH3
K	429RCV- CH3
L	429RCV+ CH4
M	429RCV- CH4
N	429TX+ CH3
P	429TX- CH3
R	429TX+ CH4
S	429TX- CH4
T	
U	
V	Mil-Std-1553 Bus A-Hi
W	Mil-Std-1553 Bus A-Lo
X	Mil-Std-1553 Bus B-Hi
Y	Mil-Std-1553 Bus B-Lo
Z	
a	RT Address bit 0
b	RT Address bit 1
c	RT Address bit 2
d	RT Address bit 3
e	RT Address bit 4
f	RT Address Parity bit
g	GND
h	
i	
j	BIT (Discrete Output)
k	GND
m	RS-232 TX UPLOAD
n	RS-232 RX UPLOAD
p	RS-232 GND
q	- unused -
r	GND
s	UPLOAD
t	GND

*ARINC-429 to 1553 pinout. For other interfaces contact Kimdu Technologies for Pinout.

Connector Definitions: ARINC-429 AND 1553

Connector Type: MIL-C-26482 Series 2

P1 - POWER

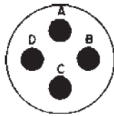

14-4

PIN	FUNCTION
A	+28VDC
B	+28VDC
C	28VDC RTN
D	28VDC RTN

Mating Connector:
MS3475L14-4S

P2 Connector

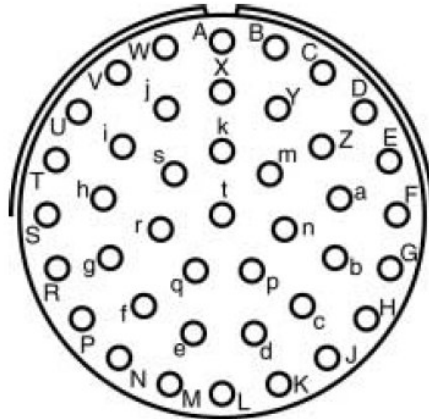

20-41

Mating Connector:
MS3475L20-41P

J2

Upload Cable Drawing



Pin m	Pin 2
Pin n	Pin 3
Pin p	Pin 5
Pin s	
Pin t	

ASIU
Side



PC
Side



DB-9 Female

Notes:

- (1) Mating connectors are not included. They can be ordered through Kimdu Corp. Contact us for details.
- (2) Pins "s" and "t" must be open on the mating connector for the unit to be in the "operating" mode. For Uploading mode, pins "s" and "t" must be shorted together.

All GND pins on the J2 connector are *sourced* by the ASIU and are at Logic Ground potential. They are meant for external wiring from the J2 connector such as RS-232 GND signal to an external device.

P2 – SIGNAL I/O*

PIN	FUNCTION
A	429RCV+ CH1
B	429RCV- CH1
C	- unused -
D	- unused -
E	429TX+ CH1
F	429TX- CH1
G	- unused -
H	- unused -
J	- unused -
K	- unused -
L	- unused -
M	- unused -
N	- unused -
P	- unused -
R	- unused -
S	- unused -
T	- unused -
U	- unused -
V	Mil-Std-1553 Bus A-Hi
W	Mil-Std-1553 Bus A-Lo
X	Mil-Std-1553 Bus B-Hi
Y	Mil-Std-1553 Bus B-Lo
Z	- unused -
a	RT Address bit 0
b	RT Address bit 1
c	RT Address bit 2
d	RT Address bit 3
e	RT Address bit 4
f	RT Address Parity bit
g	GND
h	- unused -
i	- unused -
j	BIT (Discrete Output)
k	GND
m	RS-232 TX UPLOAD
n	RS-232 RX UPLOAD
p	RS-232 GND
q	- unused -
r	- unused -
s	UPLOAD
t	GND

*USB to either ARINC-429 to 1553 pinout. For other interfaces contact Kimdu Technologies for Pinout.

Connector Definitions : ETHERNET TO ARINC-429

Connector Type: MIL-C-26482 Series 2

P1 - POWER

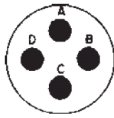

14-4

PIN	FUNCTION
A	+28VDC
B	+28VDC
C	28VDC RTN
D	28VDC RTN

Mating Connector:
MS3475L14-4S

P2 Connector

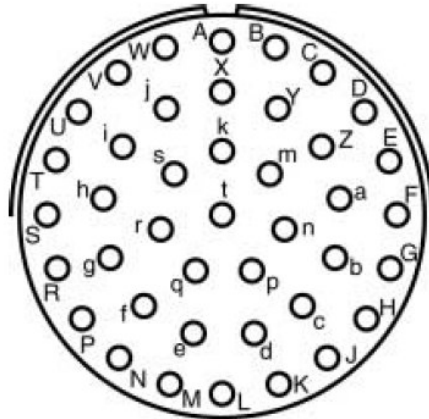

20-41

Mating Connector:
MS3475L20-41P

P2 – SIGNAL I/O*

PIN	FUNCTION
A	429RCV+ CH1
B	429RCV- CH1
C	429RCV+ CH2
D	429RCV- CH2
E	429TX+ CH1
F	429TX- CH1
G	429TX+ CH2
H	429TX- CH2
J	429RCV+ CH3
K	429RCV- CH3
L	429RCV+ CH4
M	429RCV- CH4
N	429TX+ CH3
P	429TX- CH3
R	429TX+ CH4
S	429TX- CH4
T	n.c.
U	n.c.
V	n.c.
W	ETHERNET TX +
X	ETHERNET TX -
Y	ETHERNET RX +
Z	ETHERNET RX -
a	n.c.
b	n.c.
c	n.c.
d	n.c.
e	n.c.
f	n.c.
g	n.c.
h	n.c.
i	n.c.
j	BIT (Discrete Output)
k	GND
m	RS-232 TX UPLOAD
n	RS-232 RX UPLOAD
p	RS-232 GND
q	- unused -
r	- unused -
s	UPLOAD
t	GND

J2 Upload Cable Drawing

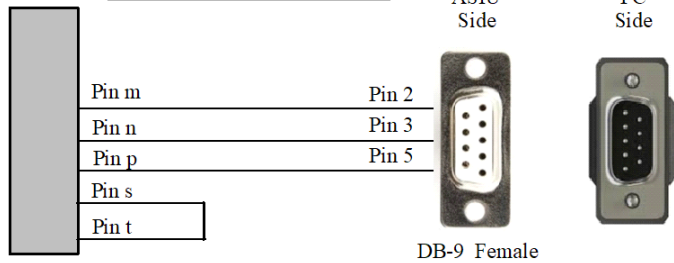

DB-9 Female

Notes:

- (1) Mating connectors are not included. They can be ordered through Kimdu Corp. Contact us for details.
- (2) Pins “s” and “t” must be open on the mating connector for the unit to be in the “operating” mode. For Uploading mode, pins “s” and “t” must be shorted together.

All GND pins on the J2 connector are *sourced* by the ASIU and are at Logic Ground potential. They are meant for external wiring from the J2 connector such as RS-232 GND signal to an external device.

*ETHERNET to ARINC-pinout. For other interfaces contact Kimdu Technologies for Pinout.

Specifications

Parameter	Value	Units
Arinc-429 and Serial Ports		
ARINC-429 SPEED	12.5/100	Kbit/sec
ARINC-429 Lightning Protection	According to DO-160D, Level 3	
Number of Serial Channels	Up to 4	
RS-232/422 Serial Port Baud Rate (CH1-4)	User Selectable	Baud (see note 1)
RS-232 Software Upload Port	115.2K	Baud
Ethernet Speed	10/100	
Mil-Std-1553 Compatibility	Mil-Std-1553B, Mil-Std-1760	
Mil-Std-1553 Modes	BC or RT or Monitor	
Enclosure		
- Moisture/Splash Resistant	IP68 Chassis tested (submerged)	
Environmental		
	MIL-E-5400T Amendment I for class 2 equipment	
- Vibration	MIL-STD-810D Method 514.3 Category 6	
- Temperature/Altitude	MIL-E-5400T Amendment I par. 3.2.24.3 except as described below.	
- Altitude	- continuous operating - up to 50,000 ft - maximum 3 min. operating - at 60,000ft - maximum 1 min. operating - at 70,000 ft	
- Sand and Dust	Designed to meet MIL-E-5400T Para. 3	
- Mechanical Shock	MIL-E-5400T par. 3.2.2.4.6.1	
- Crash Safety	RTCA/DO-160E Section 7.3	
Operating Temperature	-40 to +71	°C
Humidity	MIL-E-5400T par. 3.2.24.4	
Storage Temperature	-55 to +100	°C
- EMI	Mil-461D/E	
Power Supply		
- Nominal Input Voltage	28V DC (nominal)	
- Operating Current (typ.) (4)	100	mA
- Surge / Voltage Range	Mil-Std-704A-F for 28v nominal operation	
Connectors		
	MIL-C-26482 Series 2 (see note 2)	
Weight	525	gm (see note 3)

Notes:

- (1) Default is 115.2K. Contact factory regarding other baud rates and to select RS-422 or RS-232 Serial Channels.
- (2) Contact factory for options such as MIL-DTL-38999
- (3) Weight may differ depending upon configuration.
- (4) Operating current depends upon configuration. Contact Kimdu for additional information.

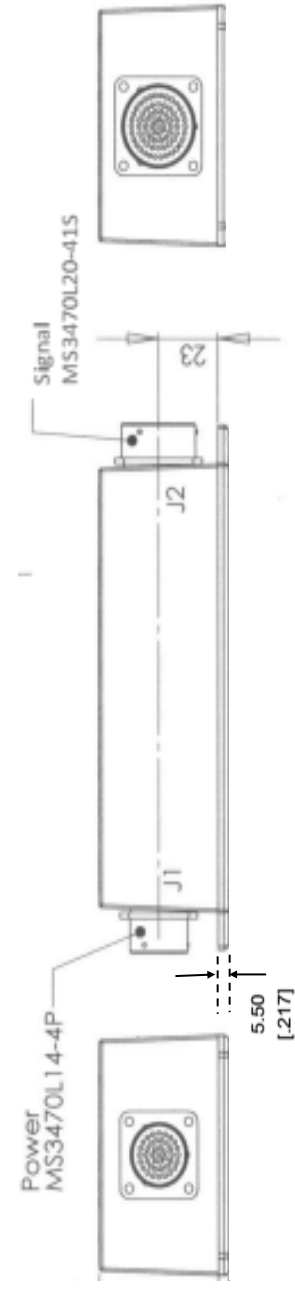
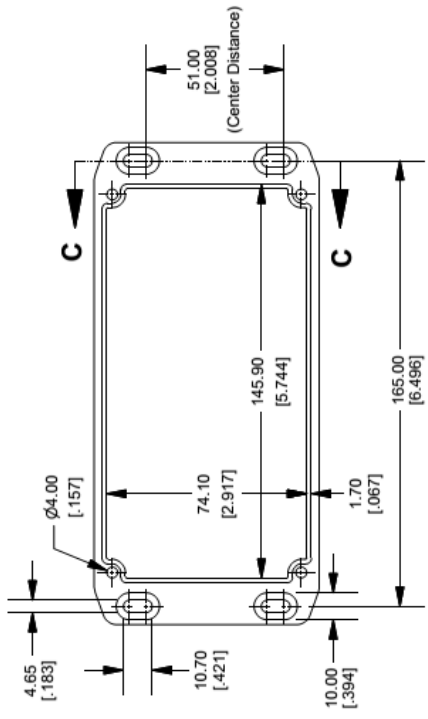
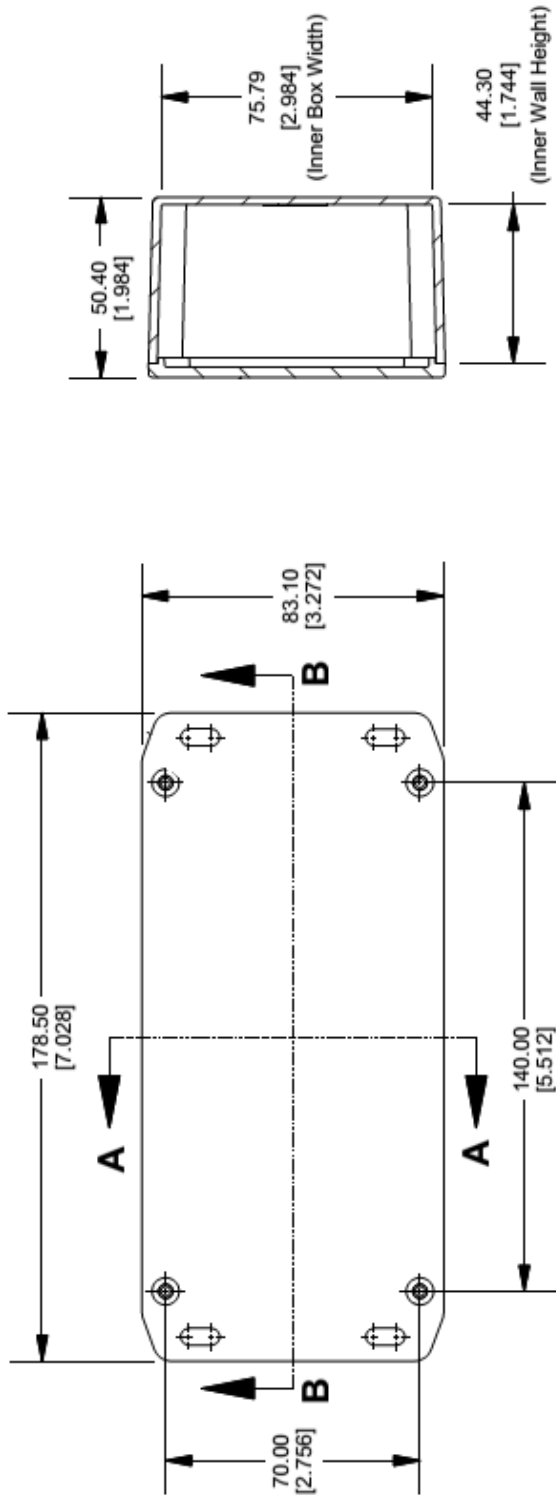

KIMDU TECHNOLOGIES
 KIMDU TECHNOLOGIES
 Avionics Serial Interface Unit
 ASIU-E-XXXXX
 DWG160210-1

Addendum A. ‘Standard’ Firmware Protocol Specification for ASIU

ASIU’s Standard Firmware allows for sending and receiving ARINC-429 to RS-232/422 without the need for DLL drivers.

Default RS-232/422 communication parameters: 115.2kbps, 8 data bits, 1 stop bit, and no parity.

Default ARINC communication parameters: High Speed, Odd parity.

<u>Command byte</u>	<u>Data byte 1</u>	<u>Data byte 2</u>	<u>Data byte 3</u>	<u>Data byte 4</u>
0xA0-0xAF – Send ARINC byte, where 0x00-0x0F determines the ARINC channel. Only 0x0-0x3 can be implemented.	ARINC label bits 1-8 (Bit 1=MSB)	ARINC data bits 32-25	ARINC data bits 24-17	ARINC data bits 16-9
0x56 – Test RS-232/422 connection. The data bytes (included) will be echoed on the RS-232/422 bus.	To be echoed	To be echoed	To be echoed	To be echoed
0x57 – Change Communication parameters. The ASIU will immediately change communication parameters upon reception of this message. It is recommended to test communication immediately after this using 0x56.	0x00 – 2400 bps 0x01 – 4800 bps 0x02 – 9600 bps 0x03 – 19200 bps 0x04 – 38400 bps 0x05 – 57600 bps 0x06 – 115200 bps All other values will fail	Ignored. (PC does not support 9 bit data, ASIU does not support 7).	0x01 – 1 stop bit 0x02 – 2 stop bits All other values will fail	0x00 – No parity 0x01 – Odd parity 0x02 – Even parity All other values will fail
0x58 – Change ARINC parameters	0x00 – High Speed 0x01 – Low Speed	0x00 – No parity 0x01 – Odd parity 0x02 – Even parity	Channel Select 0x01 – Channel 1 0x02 – Channel 2 0x04 – Channel 3 0x08 – Channel 4	Ignored

Notice that ARINC sends the 24 bits of data (bits 9-32) in big endian format (least significant byte first). For an octal label of 001 and hexadecimal data value of 123456, the data sent on the ARINC bus will be: 01 – 56 – 34 – 12. The ASIU sends data in little endian format (most significant byte first), prepended with an ARINC channel ID (value starting at hexadecimal A0 for the first channel). Therefore, for this ARINC word sent or received on, for example, ARINC channel 0, the corresponding ASIU data will be: A0 – 01 – 12 – 34 – 56.

When sending data and if parity checking is ‘on’, the parity bit will overwrite the most significant bit of the most significant byte (ARINC bit 32). For received data, the most significant bit of the data (ARINC bit 32) will be the actual value received, whether it is data or parity, and the user must decide how to handle this.

Changing ARINC Parameters: Latest Firmware Revision (as of April 2018) allows the customer to define these parameters on a Channel by Channel basis. Set the Channel select and the change will occur for the channel(s) selected. Defaults to Hi-Speed and Odd parity for all channels.

Examples:

Sending 0x58 0x01 0x00 0x0F 0x00 will change the ASIU’s ARINC port to lo-speed, no parity for *all* channels (0x0F).

Sending 0x57 0x04 0x00 0x01 0x00 will change the serial comm. parameters of the ASIU to 38400, no parity, 1 stop bit.

Sending 0x56 0x01 0x02 0x03 0x04 will echo 0x56 0x01 0x02 0x03 0x04 on the ASIUs serial port.

Sending 0xA0 0x01 0x02 0x03 0x04 will have the ASIU send, on its first channel, the label 01 with the data 0x020304 (assuming parity is not changed).

Receiving 0xA0 0x10 0x20 0x30 0x40 will mean the ASIU received, on its first channel, the label 0x10 (octal 20) the data 0x203040.

Ordering Information

ASIU-E- X- X -X- X- X - XXXX

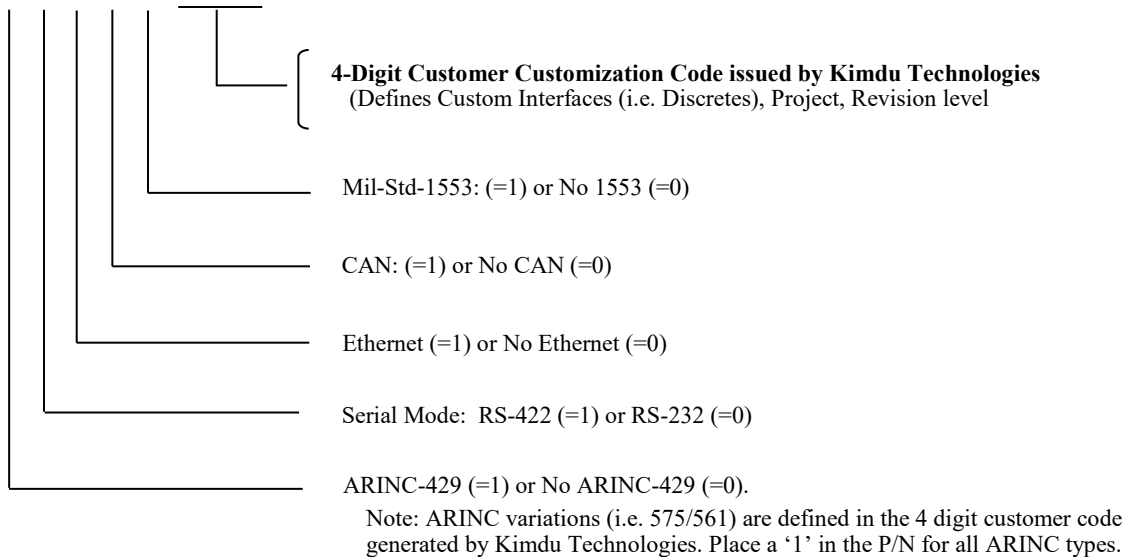

Updated in Rev O Firmware (04/18):

1. Fixed bug when transmitting Lo-Speed ARINC at maximum ARINC throughput. Some transmitted data would be dropped.
2. Added ability to modify ARINC Parameters on a channel by channel basis. Previous revisions were globally defined for all channels. Parameters are defaulted to Hi-Speed and Odd Parity.